

Ürün açıklaması/Ürün resimleri

**Açıklama****Malzeme:**

Çelik helezon.

Helezon dişli CuZn37Mn3Al2PbSi-S40.

Model:

Sağa doğru çıkan helezon, sertleştirilmiş HV 620 – 700, kenarlar ve delik taşlanmış.

Sipariş bilgisi:

Çarklar/helezonlar, sadece aynı aks mesafesi ve aynı aktarım oranı söz konusu olduğunda helezon dişli setinde kombine edilebilir.

Bilgi:

Helezon dişli seti, helezondan ve helezon dişlisinden oluşur. 90° aks açısına sahip helezon dişli kutularının üretilmesinde kullanılmaktadır. Helezon dişli kutuları ile, tek bir kademede yavaş hıza geçiş yapan büyük aktarımlar gerçekleştirilebilmektedir.

Dişlinin kenarı K biçimindedir. Tutma açısı 15°'dir. Helezon dişli setleri hazır delinmiş şekilde teslim edilir.

Belirtilen T2 tahrik çıkış torkları, helezon dişlide izin verilen tahrik çıkış torklarıdır. Bu değerler, helezonda 2800 dev/dak giriş devir sayısı için geçerlidir.

Helezon dişli setleri, yüksek devir sayılarında ve yüksek torklarda sürekli işletim için uygundur.

Çizim bilgisi:

1) taşlanmış

Ürün açıklaması/Ürün resimleri





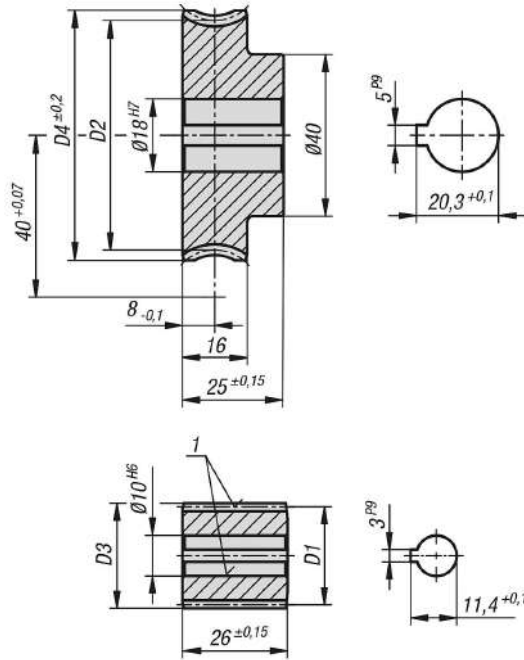













Çizimler



















Ürünler genel bakış

Sipariş numarası	Resim	Adı	Aktarma oranı	Eğim açısı	Modül	Z1	D1	D3	Z2	D2	D4	Çıkış torku T2 (Nm) Mineral gres	Çıkış torku T2 (Nm) Mineral yağ	Çıkış torku T2 (Nm) Sentetik yağ
22500-401006		Helezon	-	21° 19	2	4	22	26	-	-	-	29,5	35,4	44,2
22500-402006		Helezon Dişli	6,75:1	21° 19	2	-	-	-	27	58	64	29,5	35,4	44,2





Ürünler genel bakış

Sipariş numarası	Resim	Adı	Aktarma oranı	Eğim açısı	Modül	Z1	D1	D3	Z2	D2	D4	Çıkış torku T2 (Nm) Mineral gres	Çıkış torku T2 (Nm) Mineral yağ	Çıkış torku T2 (Nm) Sentetik yağ
														
22500-401008		Helezon	-	16° 35	2,25	3	23,64	28,14	-	-	-	27,5	33	41,2
22500-402008		Helezon Dişli	8:1	16° 35	2,25	-	-	-	24	56,36	62,5	27,5	33	41,2
22500-401010		Helezon	-	16° 1	1,9	3	20,66	24,46	-	-	-	29,5	35,4	44,2
22500-402010		Helezon Dişli	10:1	16° 1	1,9	-	-	-	30	59,34	65	29,5	35,4	44,2
22500-401012		Helezon	-	10° 21	1,5	3	25,05	28,05	-	-	-	25,2	30,2	37,8
22500-402012		Helezon Dişli	12:1	10° 21	1,5	-	-	-	36	54,95	60	25,2	30,2	37,8
22500-401015		Helezon	-	9° 53	1,9	2	22,14	25,94	-	-	-	28	33,6	42
22500-402015		Helezon Dişli	15:1	9° 53	1,9	-	-	-	30	57,86	64	28	33,6	42
22500-401020		Helezon	-	8° 59	1,5	2	19,2	22,2	-	-	-	28,9	34,6	43,3
22500-402020		Helezon Dişli	20:1	8° 59	1,5	-	-	-	40	60,8	66	28,9	34,6	43,3
22500-401025		Helezon	-	5° 58	1,15	2	22,15	24,45	-	-	-	24,4	29,2	36,6
22500-402025		Helezon Dişli	25:1	5° 58	1,15	-	-	-	50	57,85	62	24,4	29,2	36,6
22500-401028		Helezon	-	4° 47	2	1	24	28	-	-	-	28,4	34	42,6
22500-402028		Helezon Dişli	28:1	4° 47	2	-	-	-	28	56	61,5	28,4	34	42,6
22500-401030		Helezon	-	5° 50	2	1	19,68	23,68	-	-	-	30,1	36,1	45,1
22500-402030		Helezon Dişli	30:1	5° 50	2	-	-	-	30	60,32	66	30,1	36,1	45,1

Ürünler genel bakış

Sipariş numarası	Resim	Adı	Aktarma oranı	Eğim açısı	Modül	Z1	D1	D3	Z2	D2	D4	Çıkış torku T2 (Nm) Mineral gres	Çıkış torku T2 (Nm) Mineral yağ	Çıkış torku T2 (Nm) Sentetik yağ
														
22500-401035		Helezon	-	5° 26	1,75	1	18,48	21,98	-	-	-	31	37,2	46,5
22500-402035		Helezon Dişli	35:1	5° 26	1,75	-	-	-	35	61,52	67	31	37,2	46,5
22500-401036		Helezon	-	3° 19	1,5	1	25,91	28,91	-	-	-	23,9	28,6	35,8
22500-402036		Helezon Dişli	36:1	3° 19	1,5	-	-	-	36	54,09	59	23,9	28,6	35,8
22500-401040		Helezon	-	4° 20	1,5	1	19,83	22,83	-	-	-	28,3	33,9	42,4
22500-402040		Helezon Dişli	40:1	4° 20	1,5	-	-	-	40	60,17	65	28,3	33,9	42,4
22500-401050		Helezon	-	4° 8	1,25	1	17,3	19,8	-	-	-	27	32,4	40,5
22500-402050		Helezon Dişli	50:1	4° 8	1,25	-	-	-	50	62,7	68	27	32,4	40,5
22500-401056		Helezon	-	2° 23	1	1	24	26	-	-	-	21,9	26,2	32,8
22500-402056		Helezon Dişli	56:1	2° 23	1	-	-	-	56	56	59	21,9	26,2	32,8
22500-401060		Helezon	-	1° 59	0,9	1	25,92	27,72	-	-	-	19,3	23,1	28,9
22500-402060		Helezon Dişli	60:1	1° 59	0,9	-	-	-	60	54,08	57,5	19,3	23,1	28,9
22500-401070		Helezon	-	3° 3	0,9	1	16,91	18,71	-	-	-	24,1	28,9	36,1
22500-402070		Helezon Dişli	70:1	3° 3	0,9	-	-	-	70	63,09	67	24,1	28,9	36,1
22500-401075		Helezon	-	1° 48	0,75	1	23,75	25,25	-	-	-	18,8	22,5	28,2
22500-402075		Helezon Dişli	75:1	1° 48	0,75	-	-	-	75	56,26	60	18,8	22,5	28,2

rnlere genel bakıř

Sipariř numarası	Resim	Adı	Aktarma oranı	Eđim aısı	Modl	Z1	D1	D3	Z2	D2	D4	ıkıř torku T2 (Nm) Mineral gres	ıkıř torku T2 (Nm) Mineral yađ	ıkıř torku T2 (Nm) Sentetik yađ
														
22500-401080		Helezon	-	2° 10	0,75	1	19,9	21,4	-	-	-	20,1	24,1	30,1
22500-402080		Helezon Diřli	80:1	2° 10	0,75	-	-	-	80	60,1	64	20,1	24,1	30,1
22500-401090		Helezon	-	2° 22	0,7	1	16,95	18,35	-	-	-	19,1	22,9	28,6
22500-402090		Helezon Diřli	90:1	2° 22	0,7	-	-	-	90	63,05	67	19,1	22,9	28,6